

FEATURES

Full-featured evaluation board for the AD7794

Standalone USB interface

Various linking options

PC software for control of AD7794

GENERAL DESCRIPTION

This data sheet describes the evaluation board for the [AD7794](#), which is a low power, 24-bit sigma-delta (Σ - Δ) ADC. The AD7794 is a complete analog front end for low frequency measurement applications. It contains six differential inputs and includes a low noise instrumentation amplifier, an embedded reference, programmable current sources, and a low side power switch. The update rate can be varied from 4.17 Hz to 470 Hz. It also has an on-board clock eliminating the need for an external clock. It employs a Σ - Δ conversion technique to realize up to 24 bits of no missing codes performance. The input signal is applied to an analog modulator. The modulator output is

processed by an on-chip digital filter. The analog input channel of the AD7794 accepts analog input signals of $\pm V_{REF}/\text{gain}$, with gain equal to 1 to 128. With a gain of 64 and the update rate programmed to 16.7 Hz, the rms noise is 87 nV. Simultaneous 50 Hz/60 Hz rejection is available at this data update rate also.

Full data on the AD7794 is available in the AD7794 data sheet available from Analog Devices, Inc. and should be consulted in conjunction with this data sheet when using the evaluation board.

The evaluation board interfaces to the USB port of an IBM-compatible PC. Software is available with the evaluation board, which allows the user to easily communicate with the AD7794.

Note that the AD7794 evaluation board software should be installed before connecting the AD7794 evaluation board to the PC.

Other components on the AD7794 evaluation board include the [ADP3303](#) high precision, low power, 3.3 V output voltage regulator, which is used to power the USB/SPI interface.

FUNCTIONAL BLOCK DIAGRAM

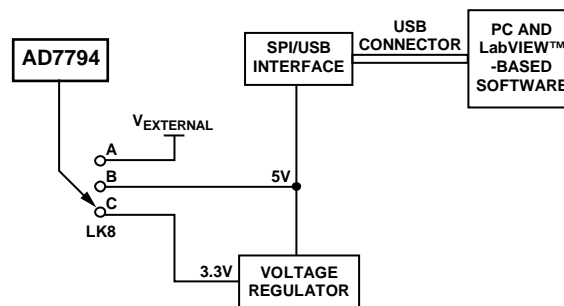

Figure 1. Functional Block Diagram

07420-001

Rev. 0

Evaluation boards are only intended for device evaluation and not for production purposes. Evaluation boards are supplied "as is" and without warranties of any kind, express, implied, or statutory including, but not limited to, any implied warranty of merchantability or fitness for a particular purpose. No license is granted by implication or otherwise under any patents or other intellectual property by application or use of evaluation boards. Information furnished by Analog Devices is believed to be accurate and reliable. However, no responsibility is assumed by Analog Devices for its use, nor for any infringements of patents or other rights of third parties that may result from its use. Analog Devices reserves the right to change devices or specifications at any time without notice. Trademarks and registered trademarks are the property of their respective owners. Evaluation boards are not authorized to be used in life support devices or systems.

TABLE OF CONTENTS

Features	1	Installing the Software.....	5
General Description	1	Using the Software	5
Functional Block Diagram	1	Main Window	6
Revision History	2	Registers Window	7
Evaluation Board Hardware.....	3	Other Registers Window	8
Power Supplies	3	Temp Demo Window	9
Links	3	Evaluation Board Schematic and Artwork.....	10
Setup Conditions	3	Ordering Information.....	13
Sockets	3	Bill of Materials.....	13
Interfacing to the Evaluation Board.....	4	Ordering Guide	13
Evaluation Board Software	5	ESD Caution.....	13
Software Description.....	5		

REVISION HISTORY

4/08—Revision 0: Initial Version

EVALUATION BOARD HARDWARE

POWER SUPPLIES

The AD7794 evaluation board is powered via the 5 V supply from the USB connector, J1. This 5 V supply can be used to power the AD7794 directly. A 3.3 V regulated voltage from the on-board ADP3303 (a high precision, low power, 3.3 V output voltage regulator) can also be used. Alternatively, the AD7794 can be powered using an external 3 V or 5 V power supply via J3.

LINKS

There are eight link options that must be set for the required operating setup before using the evaluation board. The functions of these link options are outlined in Table 1.

Table 1. Evaluation Board Link Settings

Link	Default	Description
LK1	In	This link is used to externally short AIN1(+) to AIN1(−). If V _{BIAS} is enabled and directed to AIN1(−) a noise analysis in this configuration can be performed. With this link out, an external voltage can be applied to AIN1(+)/AIN1(−) using the SMB connectors.
LK2 to LK6	Out	These links are used to connect the on-board temperature demonstration circuit to the ADC, and must all be in place when attempting to measure ambient temperature. When the on-board temperature demonstration circuit is selected in software, LK6 allows current from the on chip current source of the AD7794 to flow through the temperature demonstration circuit. When LK4 and LK5 are in place, the 1 kΩ thermistor is connected to AIN4(+)/AIN4(−). When LK2 and LK3 are in place, the 5 kΩ precision resistor is used to generate the reference for the AD7794 so a ratiometric configuration of the temperature demonstration circuit is achieved.
LK7	Out	LK7 is used to test the on-chip low-side power switch. If LK7 is in place, enabling the low-side power switch using PWR SW in the Registers window turns on the LED, D2. Clearing this bit turns off the LED.
LK8	B	LK8 is used to select the power source for AV _{DD} on the AD7794. LK8 in Position A selects an external power supply, supplied via J3. LK8 in Position B selects the 3.3 V regulated output from the on-board ADP3303 voltage regulator. LK8 in Position C selects the 5 V supply from the USB connector, J1.

Table 2. Initial Link and Switch Positions

Link No.	Position	Function
LK1	In	AIN1(+) and AIN1(−) are shorted.
LK2 to LK3	Out	Internal reference is used.
LK4 to LK5	Out	AIN4(+) and AIN4(−) are not connected to the temperature demonstration circuit.
LK6	Out	IOUT2 is not connected to temperature demonstration circuit.
LK7	Out	LED D2 is not connected to the low-side power switch of the AD7794.
LK8	B	The 3.3 V supply is used as AV _{DD} for the AD7794.

Table 3. Socket Functions

Socket	Description
AIN1(+)	Subminiature BNC (SMB) Connector. The analog input signal for the AIN1(+) input of the AD7794 is applied to this socket.
AIN1(−)	Subminiature BNC (SMB) Connector. The analog input signal for the AIN1(−) input of the AD7794 is applied to this socket.
REFIN1(+)	Subminiature BNC (SMB) Connector. This socket is used in conjunction with REFIN1− to apply an external reference to the AD7794. The voltage for the REFIN1(+) input of the AD7794 is applied to this socket.
REFIN1(−)	Subminiature BNC (SMB) Connector. This socket is used in conjunction with REFIN1+ to apply an external reference to the AD7794. The voltage for the REFIN1(−) input of the AD7794 is applied to this socket.
J2	30-pin (2 × 15) Straight Header. This socket is used in conjunction with the prototype area to interface any signal to the AD7794.

SETUP CONDITIONS

Care should be taken before applying power and signals to the evaluation board to ensure that all link positions are set per the required operating mode. Table 2 shows the position in which all the links are initially set.

SOCKETS

There are five sockets relevant to the operation of the AD7794 on this evaluation board. The functions of these sockets are outlined in Table 3.

INTERFACING TO THE EVALUATION BOARD

Interfacing to the evaluation board is via a standard USB connector, J1. J1 is used to connect the evaluation board to the USB port of a PC. A standard USB connector cable is included with the AD7794 evaluation board to allow the evaluation board to interface with the USB port of the PC. Because the board is powered via the USB connector, there is no need for an external power supply, although if preferred one may be connected via J3.

Communication between the [AD7794](#) and the PC is via the USB/SPI interface. The on-board USB controller (U2) controls this communication.

To set up the USB/SPI interface, use the following procedure:

1. Install the AD7794 evaluation board software using the supplied AD7794 evaluation board CD before connecting the board to the PC.
2. After the AD7794 evaluation board software has been installed, connect the board to the PC via J1 on the AD7794 evaluation board and via the USB port on the PC using the supplied USB connector cable. The PC automatically finds the new USB device and identifies it as the **AD779x Evaluation Board**.
3. Follow the on-screen instructions that appear. During the installation process if the **Hardware Installation Wizard** appears as shown in Figure 2, select **Continue Anyway** to successfully complete the installation of the AD7794 evaluation board.



Figure 2. Hardware Installation Window

EVALUATION BOARD SOFTWARE

SOFTWARE DESCRIPTION

The AD7794 evaluation board is shipped with a CD containing software that can be installed onto a standard PC to control the AD7794. The software communicates with the AD7794 through the USB cable, which accompanies the board. The software allows you to configure the AD7794 and to read conversion data from the AD7794. Data can be read from the AD7794 and displayed or stored for later analysis. For further information, see the AD7794 data sheet available from Analog Devices.

INSTALLATING THE SOFTWARE

Use the following steps to install the software:

1. Start Windows® and insert the CD.
2. The installation software should launch automatically. If it does not, use Windows Explorer to locate the **setup.exe** file on the CD. Double-click this file to start the installation procedure.
3. At the prompt, select a destination directory, which is **C:\Program Files\Analog Devices\AD7794** by default.
4. Once the directory is selected, the installation procedure copies the files into the relevant directories on the hard

drive. The installation program creates a program group called **Analog Devices** with a subgroup **AD7794** in the **Start** menu of the taskbar.

5. Once the installation procedure is complete, double-click on the **AD7794** icon to start the program.

USING THE SOFTWARE

Figure 3 shows the main window that is displayed when the program starts. The Main Window section briefly describes the various menu and button options on the main window. The Registers Window, Other Registers Window, and Temp Demo Window sections describe the most commonly used evaluation software windows.

The data that has been read can be exported to other packages such as MathCAD™ or Microsoft Excel for further analysis.

During power-up, the AD7794 evaluation board software configures the device to have a gain of 64, the internal reference is selected, the AIN1(-)/AIN1(-) channel is selected, the bias voltage is enabled on AIN1(-), the update rate is set to 16.7 Hz and chop is enabled.

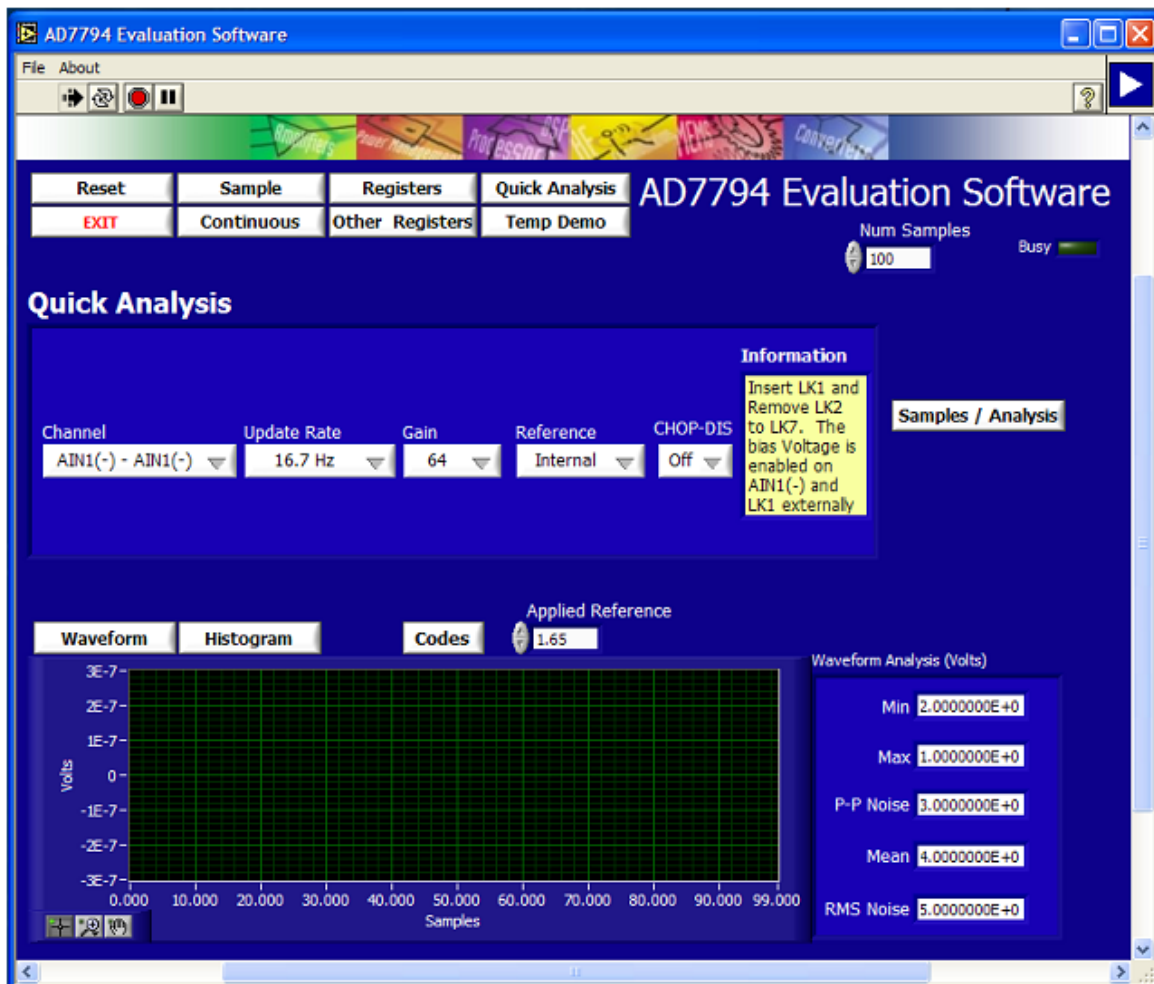

Figure 3. AD7794 Evaluation Software Main Window

EVAL-AD7794

MAIN WINDOW

Menu Bar

File

This allows the user to read previously stored data for display or analysis, write the current set of data to a file for later use, and exit the program.

About

This provides information on the revision of software used.

Buttons

Reset

This allows the user to reset the AD7794 and set the registers to the power up conditions as specified by the software (channel = AIN1(-)/AIN1(-), bias voltage generator enabled on AIN1(-), gain = 64, update rate = 16.7 Hz, internal reference, chop enabled).

Exit

This allows the user to exit the software. It serves the same purpose as **Quit** in the **File** pull-down menu.

Sample

This allows the user to read a number of samples from the AD7794. Noise analysis is then performed on the samples. These samples can be stored for further analysis. The sample size is entered in the **Num Samples** text box.

Continuous

This allows the user to read a number of samples continuously. The software gathers a number of samples as specified by the **Num Samples** text box, performs noise analysis on the samples, and then gathers the next group of samples.

Registers

This allows the user to access the configuration register, mode register, and IO register.

Other Registers

This allows the user to access the ID register, status register, offset register, and full-scale register.

Quick Analysis

This selects the **Quick Analysis** window. The **Quick Analysis** window gives the user access to the following subset of control bits: **Channel**, **Update Rate**, **Gain**, **Reference Source**, and **Chop**. For access to all control bits, click **Registers** or **Other Registers**.

Temp Demo

This allows the user to access the temperature demonstration software.

Samples/Analysis

This serves the same purpose as the **Sample** button.

Waveform

The gathered conversions are displayed in graph form.

Histogram

The gathered samples are used to generate a histogram

Codes

The gathered samples can be displayed in codes or in voltage format. When the **Codes** option is selected, the values are displayed as code. The **Codes** button changes to **Volts**. To display the information in volts, click **Volts**.

Applied Reference

By default, the internal reference is used. To use an external reference, set **Reference** in the **Registers** window to REFIN1 if the external reference is applied between REFIN1(+) and REFIN1(-) or REFIN2 if the external reference is applied between REFIN2(+) and REFIN2(-). The value of the external reference should be entered in the **Applied Reference** text box.

REGISTERS WINDOW

Click **Registers** to access the **Registers** window (see Figure 4). You can now access the configuration register, mode register, and IO register. This window allows you to change items such

as the update rate, reference source, and the clock source. Consult the [AD7794](#) data sheet for further details on the bit functions.

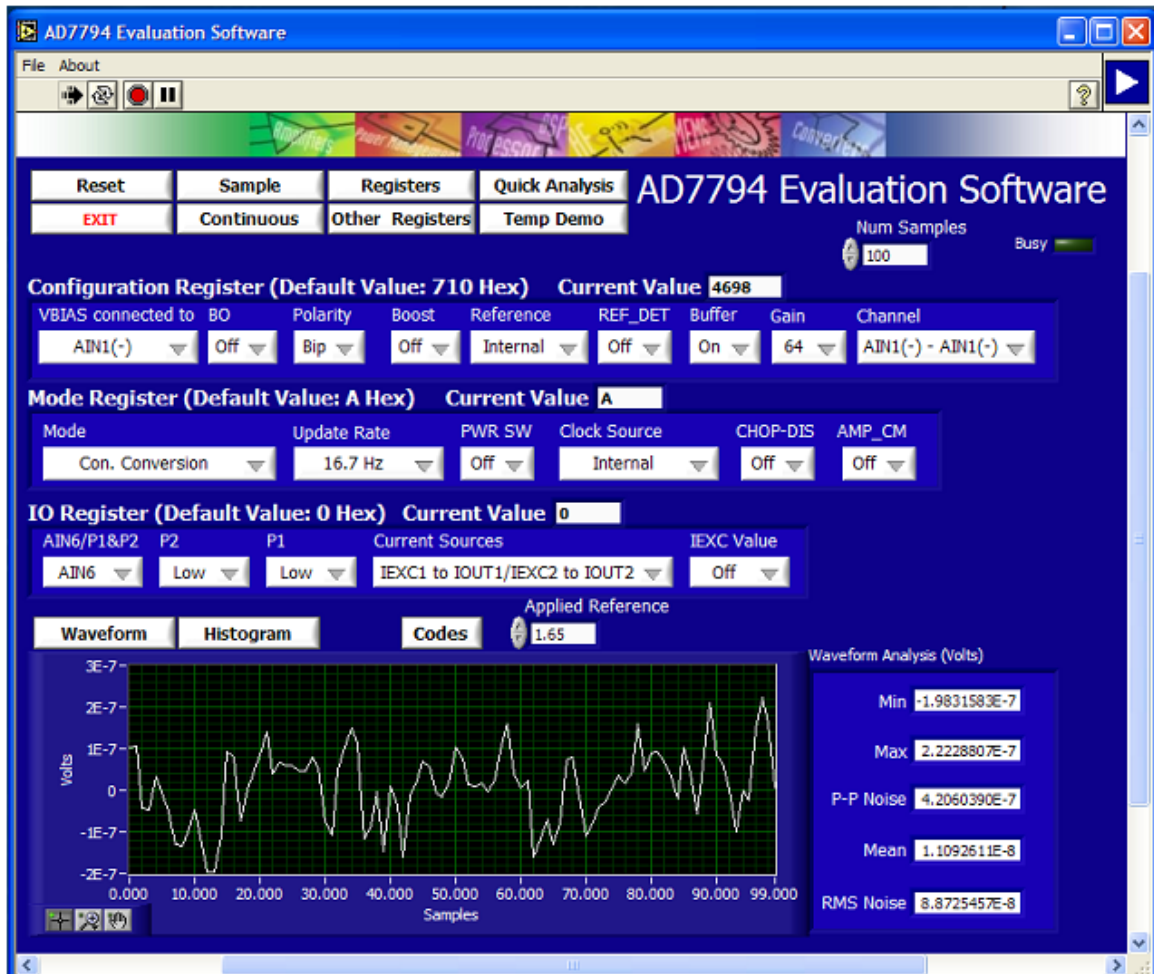

Figure 4. AD7794 Evaluation Software Registers Window

EVAL-AD7794

OTHER REGISTERS WINDOW

Click **Other Registers** to access the **Other Registers** window (see Figure 5). This window displays the contents of the status register, ID register, offset calibration register, and full-scale

calibration register. To write to the offset and full-scale calibration registers, place the **AD7794** in power-down or idle mode (using the **Registers** window).



Figure 5. AD7794 Evaluation Software Other Registers Window

TEMP DEMO WINDOW

Click **Temp Demo** to access the temperature demonstration window (see Figure 6). The AD7794 evaluation board has a temperature demonstration included on the board. To operate the temperature demonstration, LK2 to LK6 should be inserted and LK1 removed. With these links in place, the excitation current of the AD7794 is connected to a 1 k Ω thermistor which is connected across the AIN4(+)/AIN4(-) pins. In series with the thermistor is a 5 k Ω precision resistor, which is used to generate the reference voltage so that a ratiometric configuration is used. The temperature demonstration software saves the values in the mode register, configuration register, and IO register. The software then configures the AD7794 to operate

with a 210 μ A excitation current; the AIN4(+)/AIN4(-) channel is selected as the analog input, the gain is set to 1, and the external reference REFIN1(+)/REFIN1(-) is selected. When you select **Run**, the software continuously reads the conversion from the AIN4(+)/AIN4(-) channel and converts the result to temperature using a look-up table.

When **Run** is clicked again, the temperature demonstration execution is halted. To exit the temperature demonstration, click the **Back** button. The software sets the configuration register, the mode register, and the I/O register to their pretemperature demonstration values.

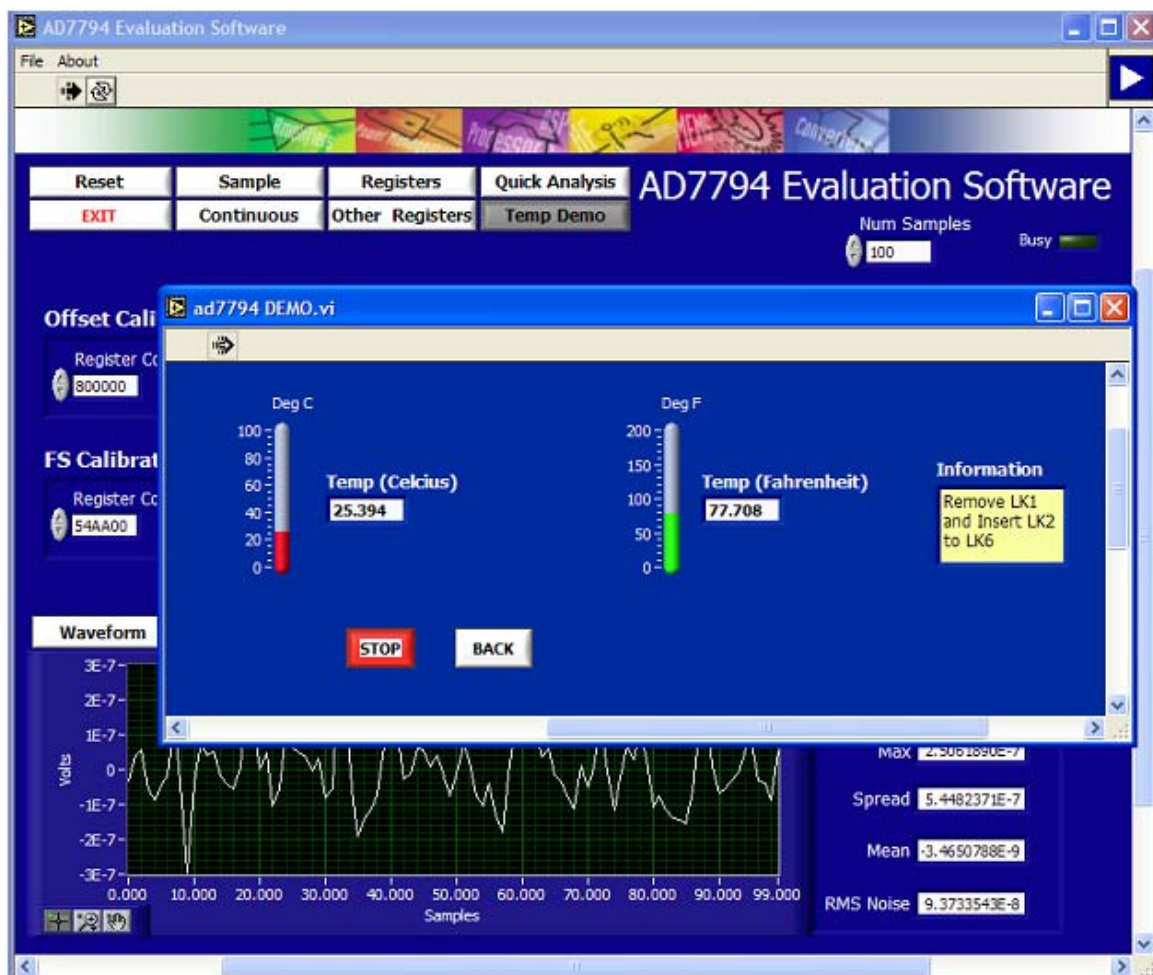

Figure 6. AD7794 Evaluation Software Temperature Demo Window

EVALUATION BOARD SCHEMATIC AND ARTWORK

07420-010

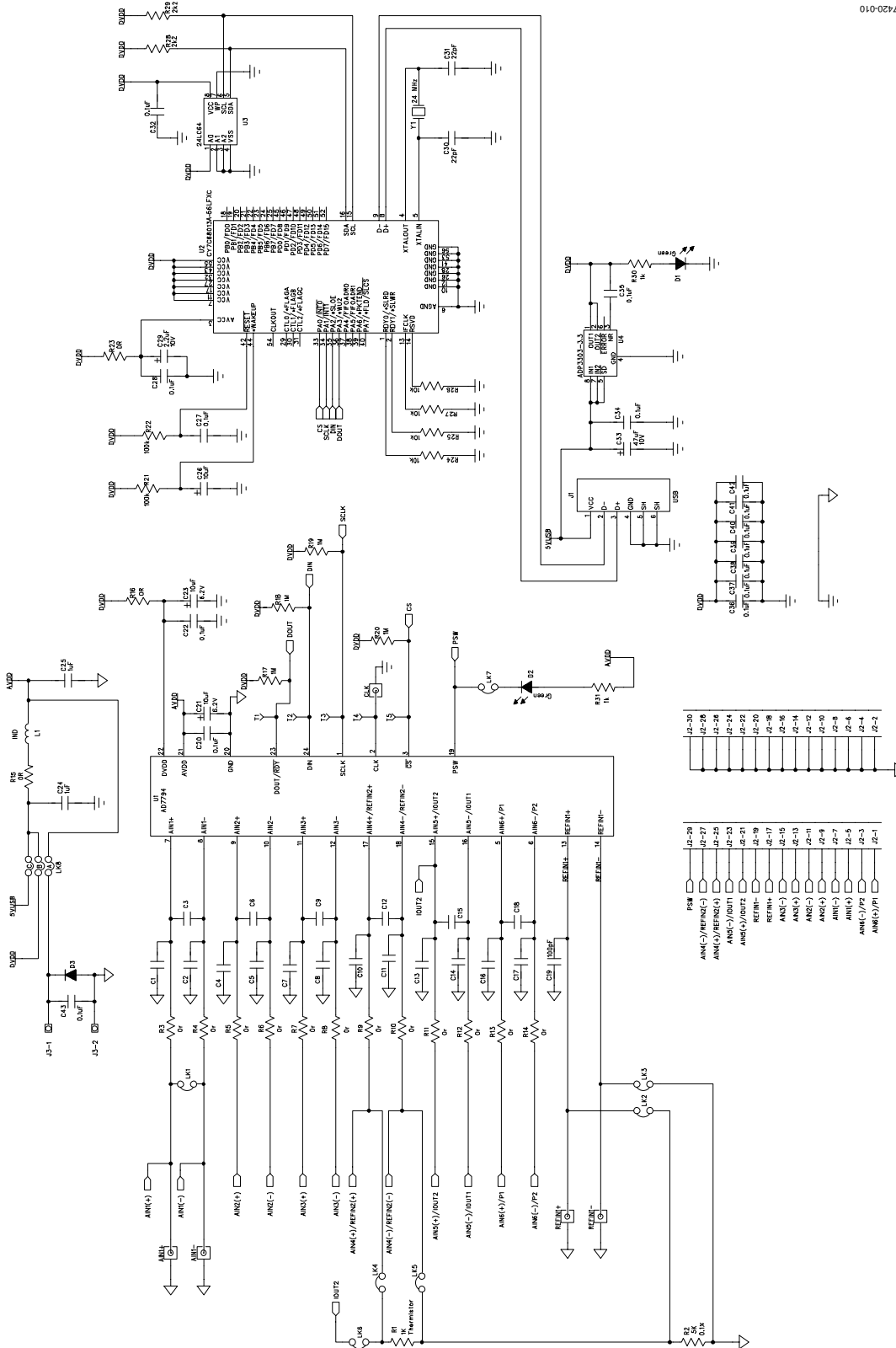

Figure 7. AD7794 Evaluation Board Schematic

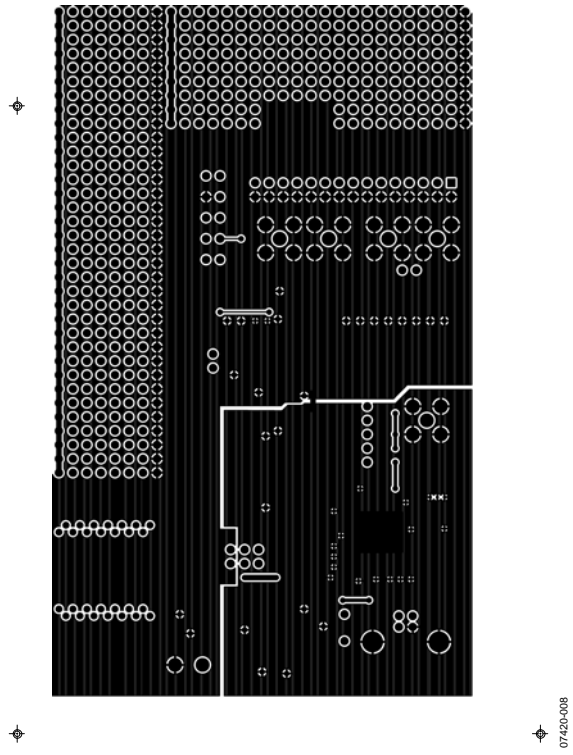

Figure 8. AD7794 Evaluation Board—Solder Side View

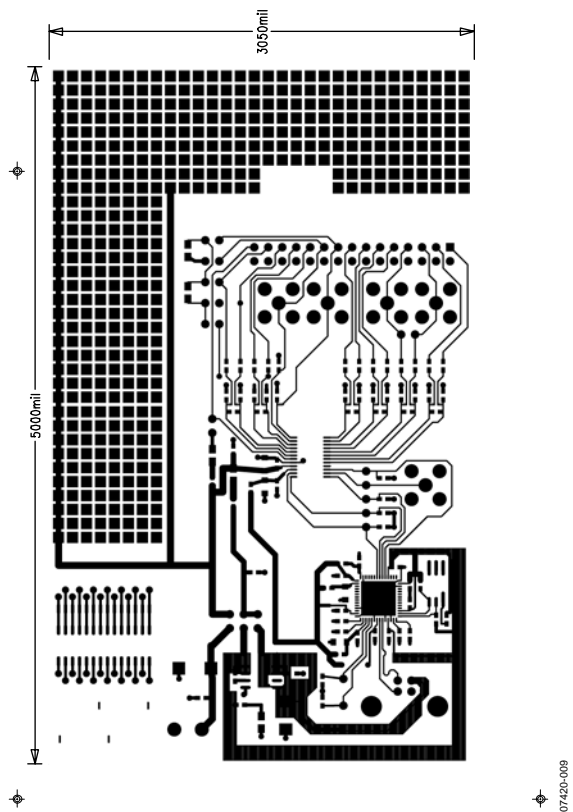

Figure 9. AD7794 Evaluation Board—Component Side View

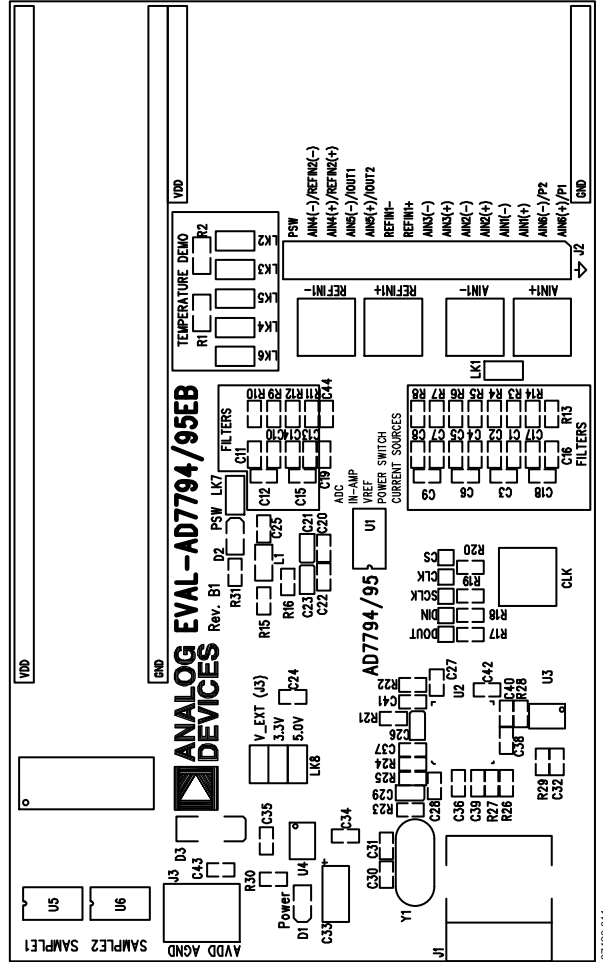

Figure 10. AD7794 Evaluation Board— Component Layout Diagram

ORDERING INFORMATION

BILL OF MATERIALS

Table 4.

Qty	Reference Designator	Description	Manufacturer/Part No.
	Integrated Circuits		
3	U1, U5, U6	AD7794BRUZ	Analog Devices
1	U2	USB controller	Cypress Semiconductor Corporation, CY7C68013A-56LFXC
1	U3	24LC64	Microchip Technology Inc., 24LC64-I/SN
1	U4	ADP3303ARZ-3.3	Analog Devices
1	Y1	24 MHz crystal	AEL Crystals, X24M000000S244
2	D1, D2	Green LED	Fairchild Semiconductor, QTLP630C-4
1	L1	Ferrite bead	Meggitt Sigma, BMB2A0300AN1
1	D3	Diode	Micro Commercial Components Corp., DL4001-TP
	Capacitors		
19	C1 to C18, C44	Capacitors	Not inserted
1	C19	100 pF ceramic	AVX Corporation, 06035A101JAT2A
15	C20, C22, C27, C28, C32, C34 to C43	0.1 μ F \pm 10% ceramic	AVX Corporation, CM105X7R104K16AT
3	C21, C23, C26	10 μ F tantalum	AVX Corporation, TAJA106K010R
2	C24, C25	1 μ F ceramic	Yageo Corporation, 2238 246 19863
1	C29	2.2 μ F tantalum	EPCOS AG, B45196E2225K109
2	C30, C31	22 pF ceramic	Yageo Corporation, 2238 867 15229
1	C33	47 μ F tantalum	AVX Corporation, TAJC476K016R
	Resistors		
1	R1	1 k Ω thermistor	EPCOS AG, B57620C102J62
1	R2	5 k Ω \pm 0.1%	Tyco Electronics Corporation, RN73C2A4K99BTG
15	R3 to R16, R23	0 Ω resistor	Multicomp, MC 0.063W 0603 0R
4	R17 to R20	1 M Ω resistor	Multicomp, MC 0.063W 0603 1% 1M
2	R21, R22	100 k Ω resistor	Multicomp, MC 0.063W 0603 1% 100K
4	R24 to R27	10 k Ω resistor	Multicomp, MC 0.063W 0603 1% 10K
2	R28, R29	2.2 k Ω resistor	Multicomp, MC 0.063W 0603 1% 2K2
2	R30, R31	1 k Ω resistor	Multicomp, MC 0.063W 0603 1% 1K
	Links		
8	LK1 to LK7 (2 \times 1 way), LK8 (3 \times 2 way)	Pin headers	Harwin Plc, M20-9983646
8	At LK1 to LK8	Shorting plugs	Harwin Plc, M7566-05
	Connectors		
4	AIN1+, AIN1-, REFIN1+, REFIN1-, CLK	SMB connector	Not inserted
1	J1	USB Mini-B connector	Molex, 565790576
1	J2	30-pin (2 \times 15) header	Harwin Plc, M20-9983646
1	J3	2-way terminal block	Camden Electronics Ltd., CTB5000/2

ORDERING GUIDE

Model	Description
EVAL-AD7794EBZ ¹	Evaluation Board

¹ Z = RoHS Compliant Part.

ESD CAUTION



ESD (electrostatic discharge) sensitive device. Charged devices and circuit boards can discharge without detection. Although this product features patented or proprietary protection circuitry, damage may occur on devices subjected to high energy ESD. Therefore, proper ESD precautions should be taken to avoid performance degradation or loss of functionality.

NOTES

NOTES

NOTES